

Fristom

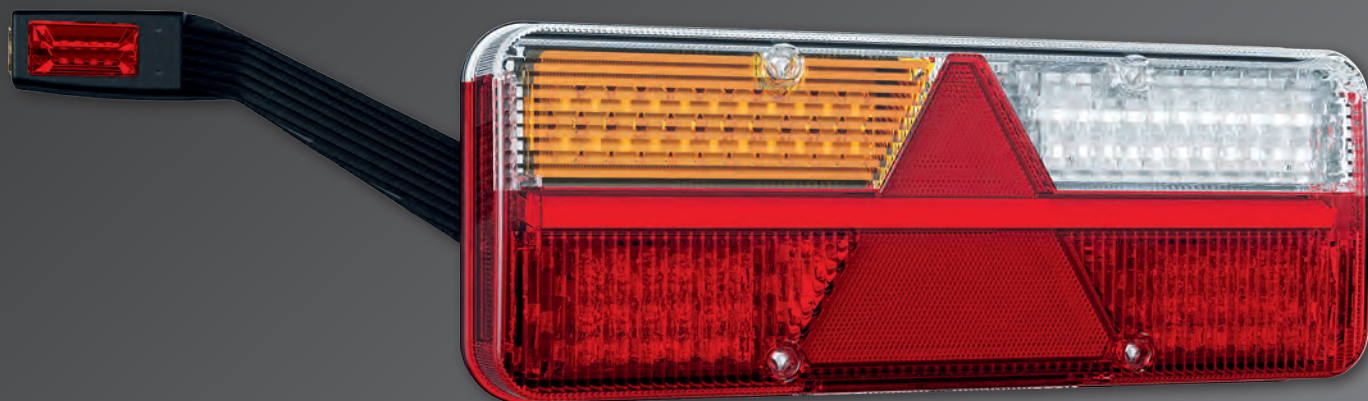

KINGPOINT FT-500 LED



***Rear Combination Lamp - 7 Function
with license plate lighting.***

FUNCTIONS:

- ↳ position lamp
- ↳ brake light
- ↳ direction indicator light
- ↳ reverse light
- ↳ fog light
- ↳ license plate light
- ↳ reflective triangle

Fristom



KINGPOINT FT-500 LED



**New, HYBRID - KINGPOINT functional lamp
from the FT-500 light group.**

What does its features look like?

- ➔ *first of all it is a HYBRID light*
- ➔ *as the user, YOU have the option of swap the light bulb with an LED panel, and vice versa*
- ➔ *replaceable light cover (you do not have to throw away your LED light when the light cover gets damaged),*
- ➔ *version with and without outline marker lamp,*
- ➔ *„load” on the LED direction indicator light,*
- ➔ *4 additional 2 PIN outputs situated on the lamp body to which you can optionally connect, for example, additional stop light, lighting for the number plate, reverse lamp, side lamps,*
- ➔ *universal spacing of mounting screws,*
- ➔ *two fuse sockets, for plate fuses, which protect optional connected lights (fuses are not standard lamp equipment),*
- ➔ *the possibility of mounting a reversing signal,*
- ➔ *dynamic LED direction indicator.*



KINGPOINT FT-500 LED

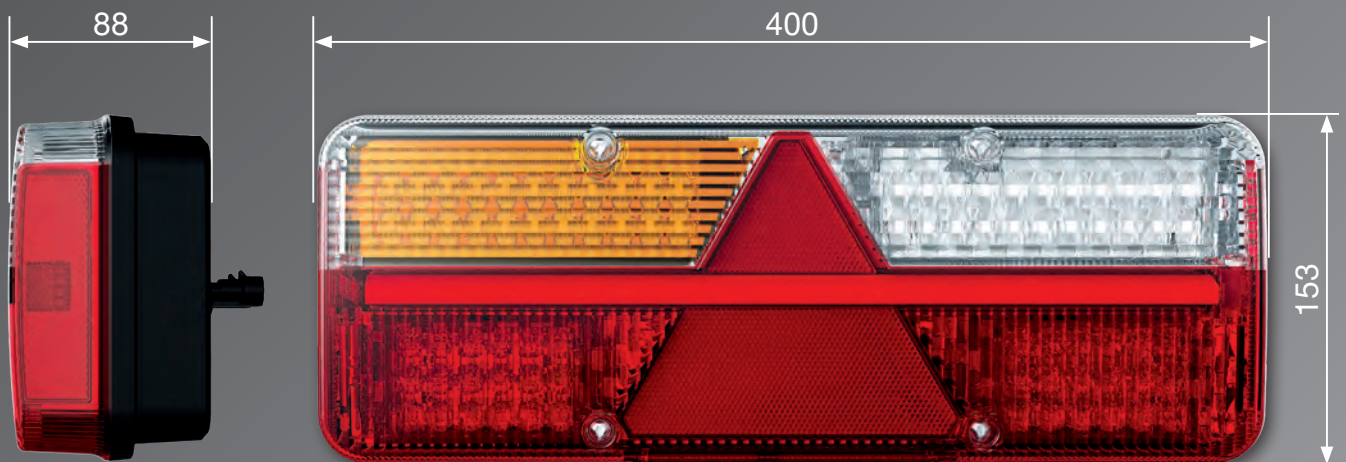
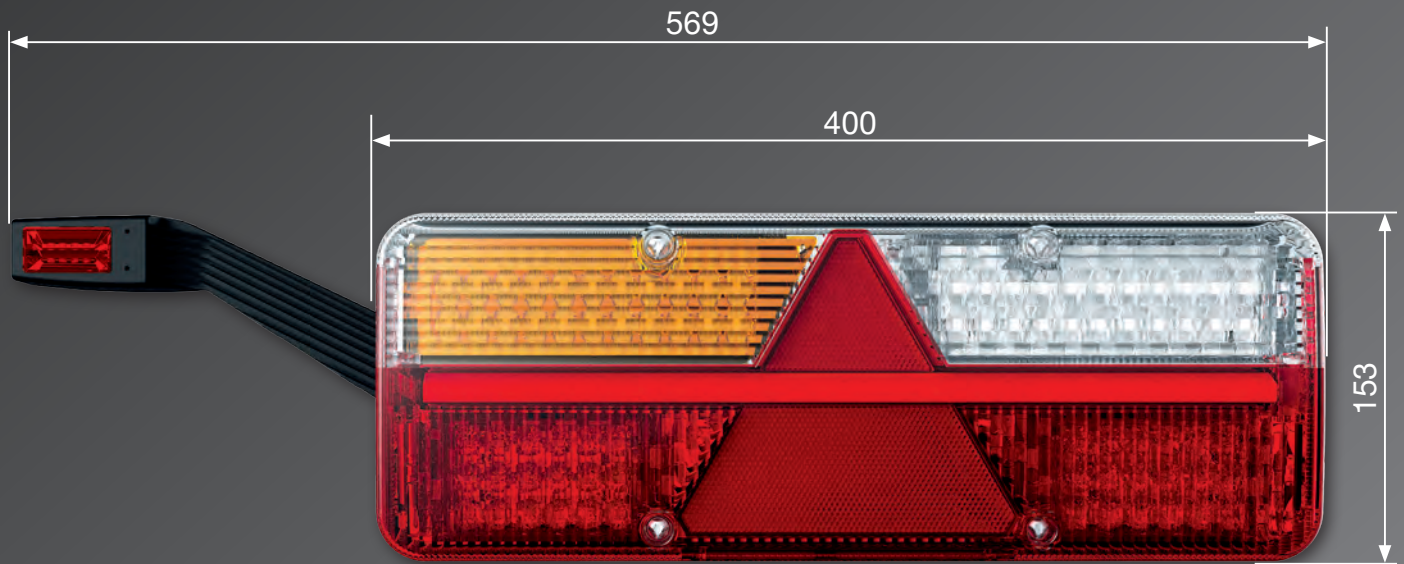



KINGPOINT FT-500 LED

The lamp comes in four rear body variants:

↪ *outlet with 2 m cable*



↪ *AMP output*



↪ *output with 2 m cable + 4, 2 PIN output (superseal type)*



↪ *AMP output + 4, 2 PIN outputs (superseal type)*

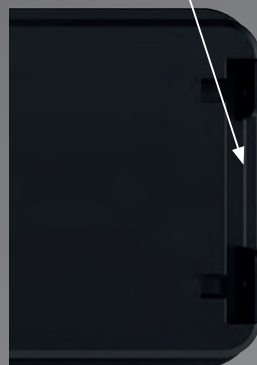

FT-145 LED lamp pouch

Fristom



KINGPOINT FT-500 LED

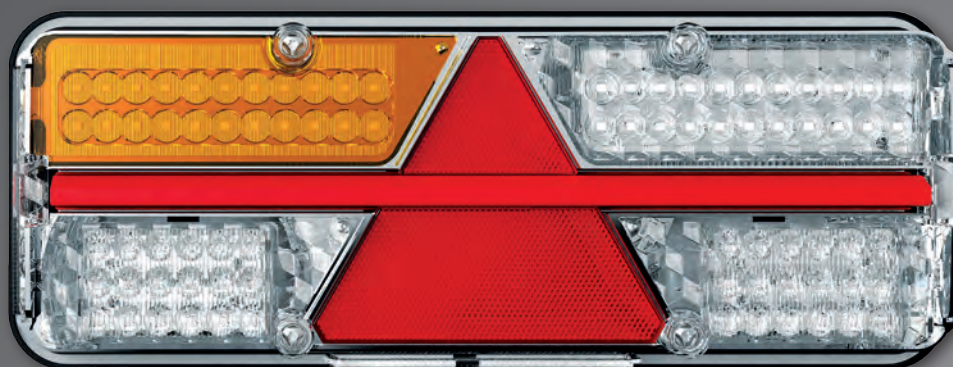
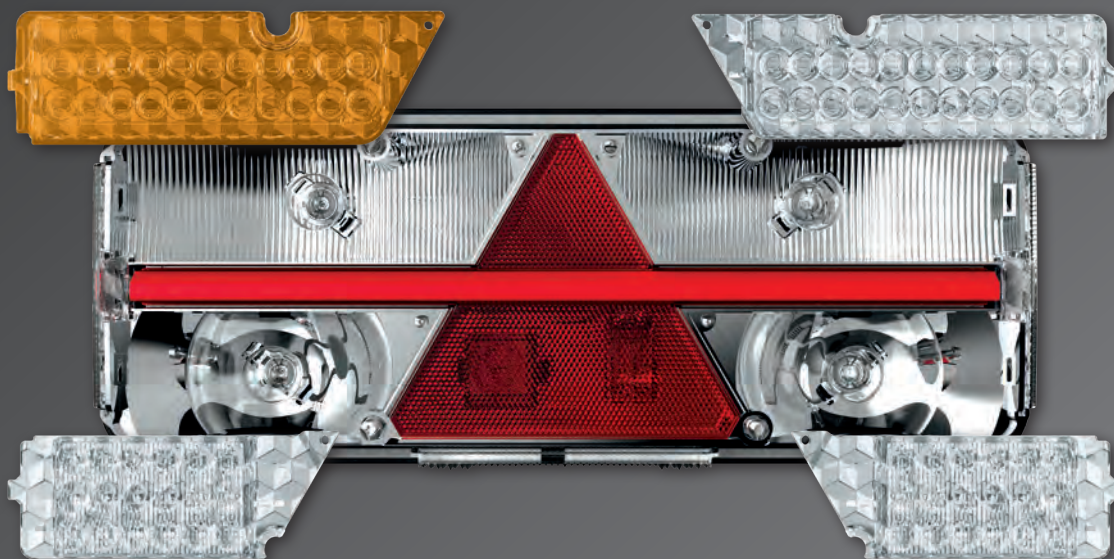

- ➔ reverse signal
- ➔ fuses
- ➔ LED version - load direction



KINGPOINT FT-500 LED

Outline marker lamp FT-145 LED



3-function LED lamp on a rubber, flexible arm

LAMP FUNCTIONS:

- ➔ front white outline marker light
- ➔ back red outline clearance light
- ➔ side yellow outline clearance light

LAMP PARAMETERS:

- ➔ supply voltage range: **12-36V DC**
- ➔ Operating temperature: **-40°C do +55°C**
- ➔ electrical connection can be connected at any polarity

POWER CONSUMPTION:

- ➔ 12V/24V = 0,1A/0,1A

POWER CONSUMPTION (POWER RATING):

- ➔ 12V/24V = 1,2W/2,4W

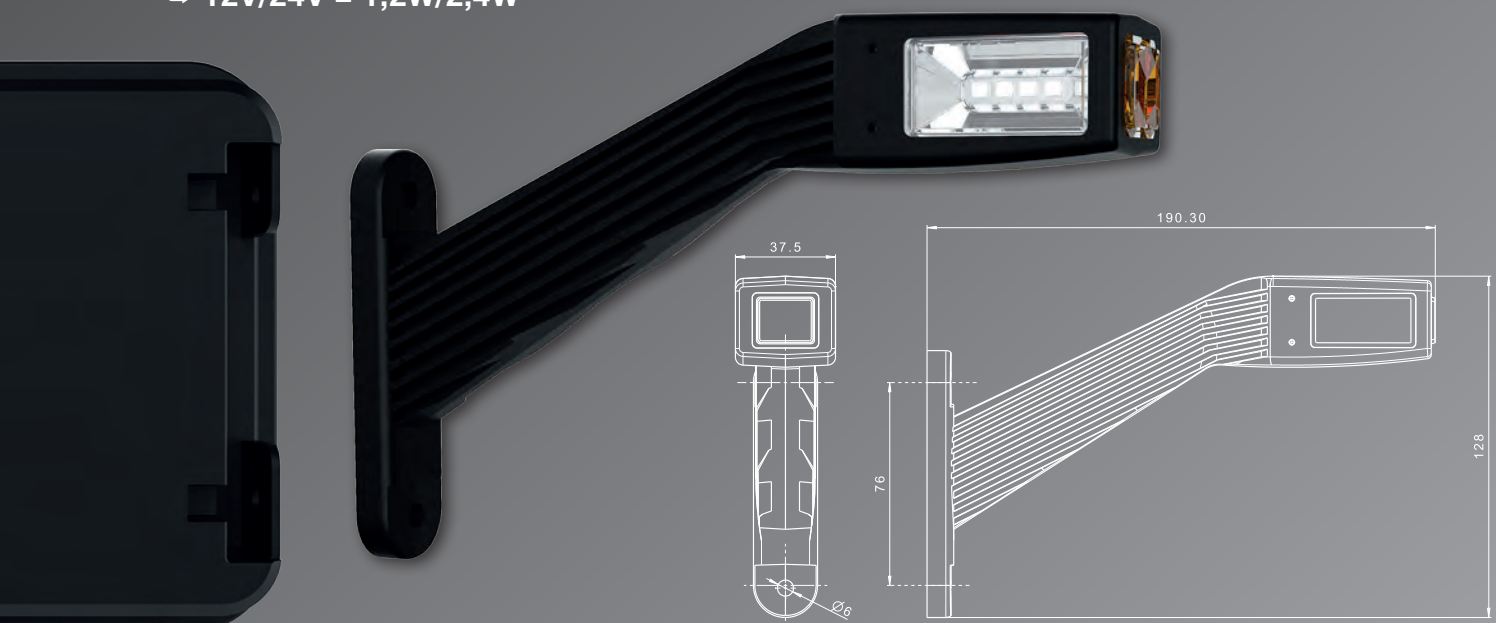



KINGPOINT FT-500 LED

Rear Combination Lamp - 7 Function with license plate lighting.

LAMP FUNCTIONS:

- ➔ position lamp
- ➔ license plate light
- ➔ brake light
- ➔ direction indicator light
- ➔ reverse light
- ➔ fog light
- ➔ reflecting

LED LAMP PARAMETERS:

- ➔ supply voltage range: **12–36V DC**
- ➔ operating temperature: **–40°C do +55°C**
- ➔ reverse polarity protection
- ➔ modules are shock resistant as well as resistant to adverse weather conditions

LED POWER CONSUMPTION:

- ➔ position light + license plate light:
12V/24V = 0,12A / 0,12A
- ➔ brake light: **12V/24V = 0,34A/0,17A**
- ➔ direction indicator light: **12V/24V = 0,4A/0,2A**
- ➔ reverse light: **12V/24V = 0,1A/0,05A**
- ➔ fog light: **12V/24V = 0,34A/0,17A**

POWER CONSUMPTION (RATED POWER):

- ➔ position light + license plate light:
12V/24V = 1,5W / 3,0W
- ➔ brake light: **12V/24V = 12V/24V = 4,1W/4,1W**
- ➔ direction indicator light: **12V/24V = 12V/24V = 5W/5W**
- ➔ reverse light: **12V/24V = 12V/24V = 1,2W/1,2W**
- ➔ fog light: **12V/24V = 12V/24V = 4,1W/4,1W**



KINGPOINT

FT-500 LED

LED version	1	2	3	4	5	6	7	8
ID	left	right	end outline marker lamp	number plate light	wire	AMP connector	superseal connector	back-up alarm
FT-500-15 LED	●				●			
FT-500-145 LED	●			●	●			
FT-500-16 LED	●					●		
FT-500-146 LED	●			●		●		
FT-500-135 LED	●		●		●			
FT-500-136 LED	●		●			●		
FT-500-1346 LED	●		●	●		●		
FT-500-1367 LED	●		●			●	●	
FT-500-25 LED		●			●			
FT-500-26 LED		●				●		
FT-500-235 LED		●	●		●			
FT-500-236 LED		●	●			●		
FT-500-2367 LED		●	●			●	●	
FT-500-23678 LED		●	●			●	●	●

BULB version	1	2	3	4	5	6	7	8
ID	left	right	end outline marker lamp	number plate light	wire	AMP connector	superseal connector	back-up alarm
FT-500-15	●				●			
FT-500-145	●			●	●			
FT-500-16	●					●		
FT-500-146	●			●		●		
FT-500-135	●		●		●			
FT-500-136	●		●			●		
FT-500-1346	●		●	●		●		
FT-500-1367	●		●			●	●	
FT-500-25		●			●			
FT-500-26		●				●		
FT-500-235		●	●		●			
FT-500-236		●	●			●		
FT-500-2367		●	●			●	●	
FT-500-23678		●	●			●	●	●